



1219 4th Avenue South
Nashville, TN 37210

Phone: (615) 254-3561
Fax: (615) 255-7673
Email: sales@richeycap.com
Web: richeycap.com

PEMB473M0400D100SB

Film Capacitors

Metallized Polyester Type
PEMB Series

Richey P/N: PEMB473M0400D100SB

Specifications:

Dimensions:

Width (W) mm: 13
Height (H) mm: 11
Thickness (T) mm: 5
Lead Spacing (P) mm: 10
Lead Diameter (d) mm: 0.6

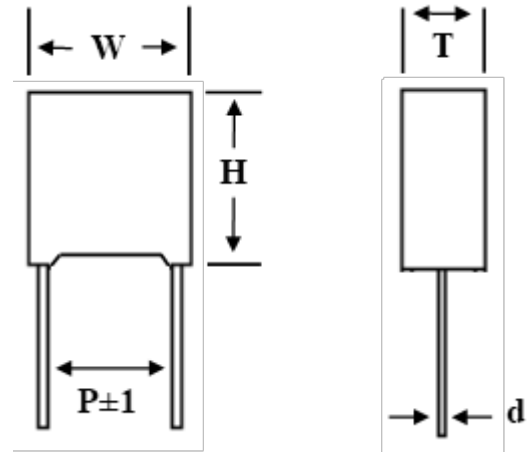

Operating Temperature Range: -40-85 °C

Rated Voltage: 400 VDC

Capacitance (μF): 0.047

Insulation Resistance (mΩ): >30000 (C ≤ 0.33μF), >1000 • uF (C > 0.33μF)

*ROHS Compliant