



1219 4th Avenue South  
Nashville, TN 37210

**Phone:** (615) 254-3561  
**Fax:** (615) 255-7673  
**Email:** sales@richeycap.com  
**Web:** richeycap.com

# PEMB153M0100D100SB

Film Capacitors

Metallized Polyester Type  
PEMB Series

Richey P/N: PEMB153M0100D100SB

## Specifications:

Dimensions:

Width (W) mm: 13  
Height (H) mm: 9  
Thickness (T) mm: 4  
Lead Spacing (P) mm: 10  
Lead Diameter (d) mm: 0.6

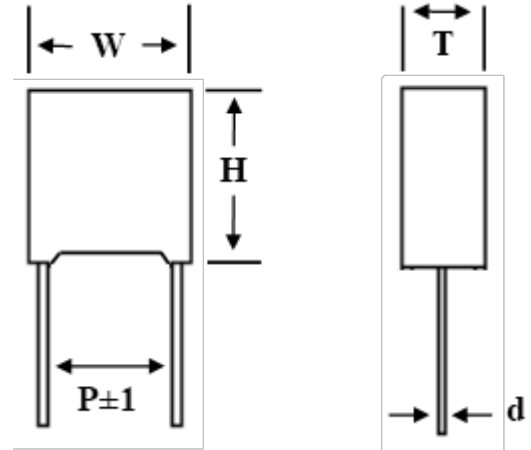

Operating Temperature Range: -40-85 °C

Rated Voltage: 100 VDC

Capacitance (μF): 0.015

Insulation Resistance (mΩ): >30000 (C ≤ 0.33μF), >1000 • uF (C > 0.33μF)

\*ROHS Compliant